

2020

UNITED STATES
SUPPLEMENTAL DISTRIBUTOR PRICE LIST

PRICES EFFECTIVE
11/01/2020



Table of Contents

Wall Ovens.....	3
E Series Ovens	4
Convection Steam Ovens.....	6
Convection Speed Ovens.....	7
Microwave Ovens.....	8
Warming Drawer	12
Coffee System	13
Ranges	14
Induction Ranges.....	15
Dual Fuel Ranges	17
Wolf Warranties	30

Model numbers, specifications, and prices are subject to change at any time without notice. Visit wolfappliance.com/specs, for the most up-to-date information.

IMPORTANT NOTE: Throughout this price list, dimensions in parentheses are in millimeters unless otherwise specified.

NOTE ALSO: Use of Manufacturer’s Suggested Retail Price (“MSRP”) is subject to the requirements of Section 1.6 of the Sub-Zero Distributor Agreement, as amended.



Indicates Wi-Fi enabled.



Indicates Star-K certified.

The information and images in this guide are the copyright property of Sub-Zero, Inc. Neither this guide nor any information or images contained herein may be copied or used in whole or in part without the express written permission of Sub-Zero, Inc. ©Sub-Zero, Inc. all rights reserved.

Sub-Zero, Sub-Zero & Design, Sub-Zero & Snowflake Design, Dual Refrigeration, The Living Kitchen, Great American Kitchens The Fine Art of Kitchen Design, Wolf, Wolf & Design, Wolf Gourmet, W & Design, red colored knobs, Cove, and Cove & Design, are registered trademarks and service marks of Sub-Zero Group, Inc. and its subsidiaries.

All other trademarks are property of their respective owners in the United States and other countries.



Wall Ovens

These are the ovens that took the cooking world by storm, bringing professional performance into the home kitchen. Bake, roast, and broil with the confidence of Wolf Convection, Convection Steam, Convection Speed, and Microwave Built-In Ovens. They offer intuitive controls and consistent temperatures to ensure every meal is predictably remarkable.

MODEL NUMBER KEY

Single Oven	SO
Double Oven	DO
Convection Steam Oven	CSO
Speed Oven	SPO
Drop-Down Door Microwave Oven	MDD
Drawer Microwave Oven	MD
Convection Microwave Oven	MC
Standard Microwave Oven	MS
Warming Drawer	WWD
E Series Transitional	TE
E Series Professional	PE
Stainless Steel	S
Tubular Handle	T or TH
Pro Handle	P or PH

E Series Ovens

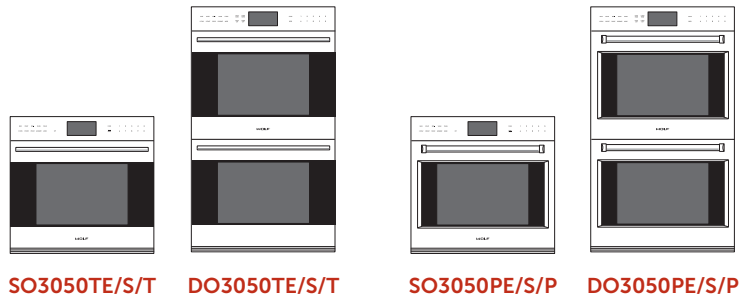

Convection Steam Ovens



Convection Speed Ovens

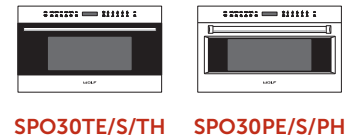

Drop-Down Door Microwave Ovens

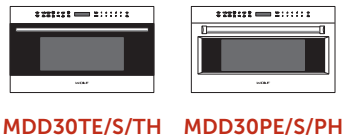

Drawer Microwave Ovens



Convection Microwave Oven



Standard Microwave Oven



Warming Drawer



E Series Ovens

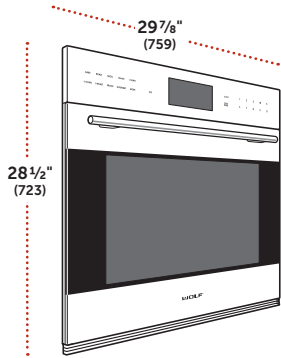

30" E Series Transitional Single Oven

MODEL	MSRP
SO3050TE/S/T	\$4,770

SPECIFICATIONS

Overall Dimensions	29 7/8" W (759) x 28 1/2" H (723) x 23" D (584)
Interior Capacity	4.7 cu ft (133 L)
Interior Dimensions	25 1/4" W (642) x 17 1/2" H (445) x 18 1/2" D (470)
Shipping Weight	257 lbs (117 kg)

FEATURES

- Stainless steel
- Standard or flush inset installation
- 3/4" tubular handle
- Dual convection with 10 cooking modes including Gourmet
- Large full-color touchscreen and stainless touch controls
- 1 standard and 2 full-extension ball bearing racks
- Broiler pan and temperature probe

Accessories

DESCRIPTION	NUMBER	MSRP
Oven Racks		
Full-Ext Ball Bearing Rack	829241	\$170
Standard Oven Rack	829240	\$80
Dehydration Rack Set (2)	823247	\$180
30" (762) Baking Sheet	823269	\$70
Multifunction Pan/Rack	829265	\$230
Temperature Probe	823261	\$70
Broiler Pan	819377	\$60
Bake Stone Kit	9016697	\$230
Dual Installation Kit*	826001	N/C

*Dual installation kit required for side by side installations.

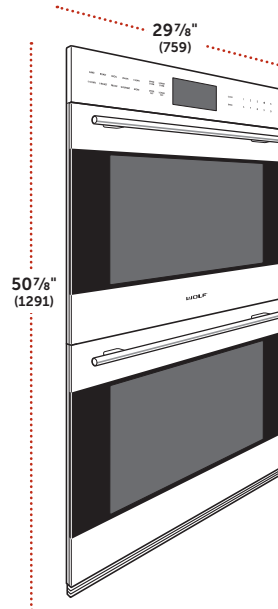

30" E Series Transitional Double Oven

MODEL	MSRP
DO3050TE/S/T	\$7,155

SPECIFICATIONS

Overall Dimensions	29 7/8" W (759) x 50 7/8" H (1291) x 23" D (584)
Capacity (per oven)	4.7 cu ft (133 L)
Interior Dimensions	25 1/4" W (642) x 17 1/2" H (445) x 18 1/2" D (470)
Shipping Weight	446 lbs (202 kg)

FEATURES

- Stainless steel
- Standard or flush inset installation
- 3/4" tubular handle
- Dual convection upper oven with a conventional lower oven
- 10 cooking modes including Gourmet in upper oven
- Large full-color touchscreen and stainless touch controls
- 1 standard and 2 full-extension ball bearing racks (per oven)
- Broiler pan and temperature probe

Accessories

DESCRIPTION	NUMBER	MSRP
Oven Racks		
Full-Ext Ball Bearing Rack	829241	\$170
Standard Oven Rack	829240	\$80
Dehydration Rack Set (2)	823247	\$180
30" (762) Baking Sheet	823269	\$70
Multifunction Pan/Rack	829265	\$230
Temperature Probe	823261	\$70
Broiler Pan	819377	\$60
Bake Stone Kit	9016697	\$230

E Series Ovens

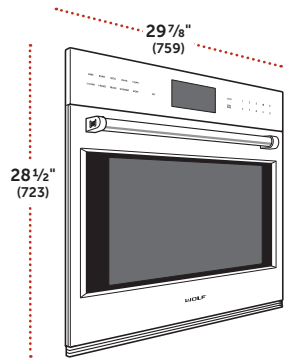

30" E Series Professional Single Oven

MODEL	MSRP
SO3050PE/S/P	\$4,795

SPECIFICATIONS

Overall Dimensions	29 7/8" W (759) x 28 1/2" H (723) x 23" D (584)
Interior Capacity	4.7 cu ft (133 L)
Interior Dimensions	25 1/4" W (642) x 17 1/2" H (445) x 18 1/2" D (470)
Shipping Weight	257 lbs (117 kg)

FEATURES

- Stainless steel
- Standard or flush inset installation
- Pro handle
- Dual convection with 10 cooking modes including Gourmet
- Large full-color touchscreen and stainless touch controls
- 1 standard and 2 full-extension ball bearing racks
- Broiler pan and temperature probe

Accessories

DESCRIPTION	NUMBER	MSRP
Oven Racks		
Full-Ext Ball Bearing Rack	829241	\$170
Standard Oven Rack	829240	\$80
Dehydration Rack Set (2)	823247	\$180
30" (762) Baking Sheet	823269	\$70
Multifunction Pan/Rack	829265	\$230
Temperature Probe	823261	\$70
Broiler Pan	819377	\$60
Bake Stone Kit	9016697	\$230
Dual Installation Kit*	826001	N/C

*Dual installation kit required for side by side installations.

Prices Effective
11/01/2020

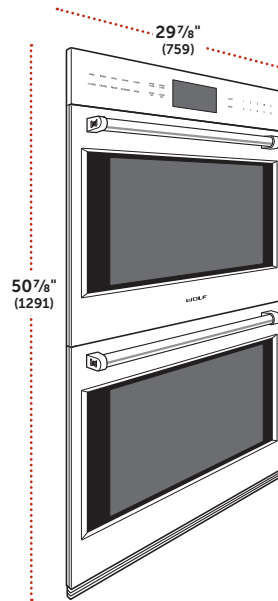

30" E Series Professional Double Oven

MODEL	MSRP
DO3050PE/S/P	\$7,210

SPECIFICATIONS

Overall Dimensions	29 7/8" W (759) x 50 7/8" H (1291) x 23" D (584)
Capacity (per oven)	4.7 cu ft (133 L)
Interior Dimensions	25 1/4" W (642) x 17 1/2" H (445) x 18 1/2" D (470)
Shipping Weight	446 lbs (202 kg)

FEATURES

- Stainless steel
- Standard or flush inset installation
- Pro handle
- Dual convection upper oven with a conventional lower oven
- 10 cooking modes including Gourmet in upper oven
- Large full-color touchscreen and stainless touch controls
- 1 standard and 2 full-extension ball bearing racks (per oven)
- Broiler pan and temperature probe

Accessories

DESCRIPTION	NUMBER	MSRP
Oven Racks		
Full-Ext Ball Bearing Rack	829241	\$170
Standard Oven Rack	829240	\$80
Dehydration Rack Set (2)	823247	\$180
30" (762) Baking Sheet	823269	\$70
Multifunction Pan/Rack	829265	\$230
Temperature Probe	823261	\$70
Broiler Pan	819377	\$60
Bake Stone Kit	9016697	\$230

Convection Steam Ovens

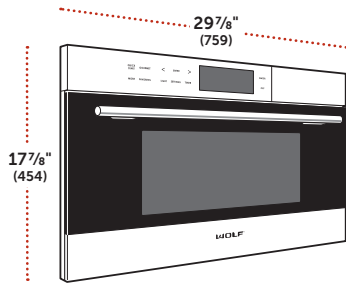

30" E Series Transitional Convection Steam Oven

MODEL	MSRP
CSO30TE/S/TH	\$4,975

SPECIFICATIONS

Overall Dimensions	29 ⁷ / ₈ "W (759) x 17 ⁷ / ₈ "H (454) x 21 ¹ / ₂ "D (546)
Interior Capacity	1.8 cu ft (51 L)
Interior Dimensions	17 ⁷ / ₈ "W (454) x 11"H (280) x 15 ³ / ₄ "D (400)
Power	3800 W
Shipping Weight	80 lbs (36 kg)

FEATURES

- Stainless steel
- Standard or flush inset installation
- ¾" tubular handle
- Convection with 13 cooking modes
- 2 wire oven racks
- 1 perforated and 1 solid 17³/₄" x 1" x 15" pan
- Temperature probe

Accessories

DESCRIPTION	NUMBER	MSRP
Perforated Pan		
12 ³ / ₄ " x 1 ¹ / ₂ " x 7"	819999	\$150
12 ³ / ₄ " x 2 ¹ / ₂ " x 7"	820018	\$180
17 ³ / ₄ " x 1 ¹ / ₄ " x 15"	821212	\$210
Solid Pan		
12 ³ / ₄ " x 1 ¹ / ₂ " x 7"	820016	\$120
12 ³ / ₄ " x 1 ¹ / ₄ " x 14"	827037	\$150
17 ³ / ₄ " x 1 ¹ / ₄ " x 15"	821210	\$170
Porcelain Baking Sheet	821228	\$120
Oven Rack	821218	\$150
Full-Extension Rack Guides	821718	\$480
Descaling Solution (10)	823403	N/A

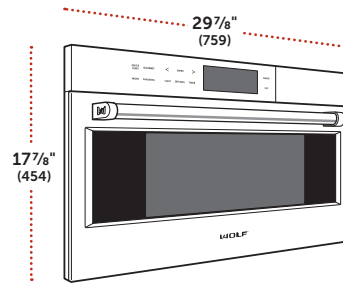

30" E Series Professional Convection Steam Oven

MODEL	MSRP
CSO30PE/S/PH	\$5,000

SPECIFICATIONS

Overall Dimensions	29 ⁷ / ₈ "W (759) x 17 ⁷ / ₈ "H (454) x 21 ¹ / ₂ "D (546)
Interior Capacity	1.8 cu ft (51 L)
Interior Dimensions	17 ⁷ / ₈ "W (454) x 11"H (280) x 15 ³ / ₄ "D (400)
Power	3800 W
Shipping Weight	80 lbs (36 kg)

FEATURES

- Stainless steel
- Standard or flush inset installation
- Pro handle
- Convection with 13 cooking modes
- 2 wire oven racks
- 1 perforated and 1 solid 17³/₄" x 1" x 15" pan
- Temperature probe

Accessories

DESCRIPTION	NUMBER	MSRP
Perforated Pan		
12 ³ / ₄ " x 1 ¹ / ₂ " x 7"	819999	\$150
12 ³ / ₄ " x 2 ¹ / ₂ " x 7"	820018	\$180
17 ³ / ₄ " x 1 ¹ / ₄ " x 15"	821212	\$210
Solid Pan		
12 ³ / ₄ " x 1 ¹ / ₂ " x 7"	820016	\$120
12 ³ / ₄ " x 1 ¹ / ₄ " x 14"	827037	\$150
17 ³ / ₄ " x 1 ¹ / ₄ " x 15"	821210	\$170
Porcelain Baking Sheet	821228	\$120
Oven Rack	821218	\$150
Full-Extension Rack Guides	821718	\$480
Descaling Solution (10)	823403	N/A

Convection Speed Ovens

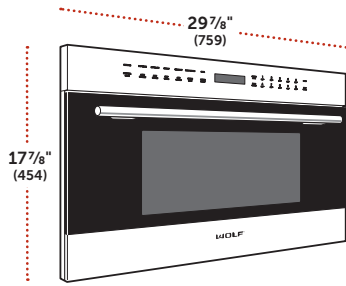

30" E Series Transitional Speed Oven

MODEL	MSRP
SPO30TE/S/TH	\$2,665

SPECIFICATIONS

Overall Dimensions	29 7/8"W (759) x 17 7/8"H (454) x 21 1/2"D (546)
Interior Capacity	1.6 cu ft (46 L)
Interior Dimensions	17 3/4"W (451) x 9 1/8"H (232) x 17"D (432)
Shipping Weight	105 lbs (48 kg)

FEATURES

- Stainless steel interior
- Dual broil 750 W (1500 W total)
- LED lit interior
- Convection
- Standard or flush inset installation
- Designed to match Wolf ovens

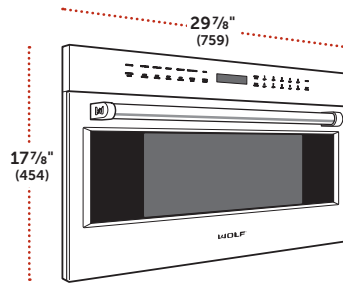

30" E Series Professional Speed Oven

MODEL	MSRP
SPO30PE/S/PH	\$2,770

SPECIFICATIONS

Overall Dimensions	29 7/8"W (759) x 17 7/8"H (454) x 21 1/2"D (546)
Interior Capacity	1.6 cu ft (46 L)
Interior Dimensions	17 3/4"W (451) x 9 1/8"H (232) x 17"D (432)
Shipping Weight	105 lbs (48 kg)

FEATURES

- Stainless steel interior
- Dual broil 750 W (1500 W total)
- LED lit interior
- Convection
- Standard or flush inset installation
- Designed to match Wolf ovens

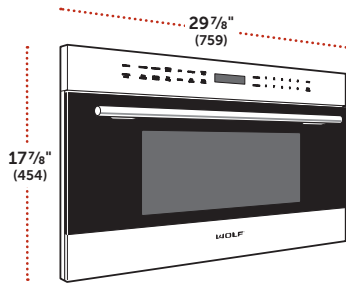

30" E Series Transitional Drop-Down Door Microwave Oven

MODEL	MSRP
MDD30TE/S/TH	\$2,190

SPECIFICATIONS

Overall Dimensions	29 ⁷ / ₈ "W (759) x 17 ⁷ / ₈ "H (454) x 20"D (508)
Interior Capacity	1.6 cu ft (45 L)
Interior Dimensions	17 ³ / ₄ "W (451) x 9 ¹ / ₈ "H (232) x 17"D (432)
Power	900 W
Shipping Weight	80 lbs (36 kg)

FEATURES

- 9 cooking modes
- Standard or flush inset installation
- Designed to match Wolf ovens

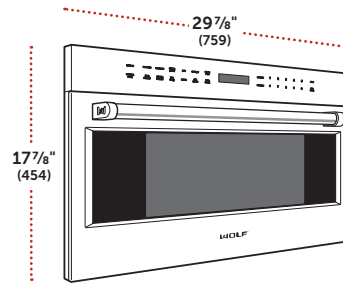

30" E Series Professional Drop-Down Door Microwave Oven

MODEL	MSRP
MDD30PE/S/PH	\$2,295

SPECIFICATIONS

Overall Dimensions	29 ⁷ / ₈ "W (759) x 17 ⁷ / ₈ "H (454) x 20"D (508)
Interior Capacity	1.6 cu ft (45 L)
Interior Dimensions	17 ³ / ₄ "W (451) x 9 ¹ / ₈ "H (232) x 17"D (432)
Power	900 W
Shipping Weight	80 lbs (36 kg)

FEATURES

- 9 cooking modes
- Standard or flush inset installation
- Designed to match Wolf ovens

Microwave Ovens

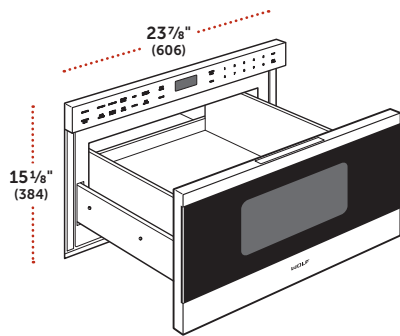

24" Transitional Drawer Microwave Oven

MODEL	MSRP
MD24TE/S	\$2,050

SPECIFICATIONS

Overall Dimensions	23 ⁷ / ₈ " W (606) x 15 ¹ / ₈ " H (384) x 21 ⁷ / ₈ " D (556)
Interior Capacity	1.2 cu ft (34 L)
Interior Dimensions	17 ⁵ / ₁₆ " W (440) x 7 ¹ / ₈ " H (181) x 16 ⁹ / ₁₆ " D (421)
Power	950 W
Shipping Weight	91 lbs (41 kg)

FEATURES

- Stainless steel
- Standard or flush inset installation

Accessories

DESCRIPTION	NUMBER	MSRP
Flush Inset Vent	822113	\$40

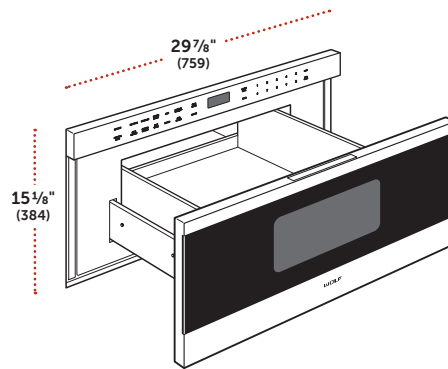

30" Transitional Drawer Microwave Oven

MODEL	MSRP
MD30TE/S	\$2,105

SPECIFICATIONS

Overall Dimensions	29 ⁷ / ₈ " W (759) x 15 ¹ / ₈ " H (384) x 21 ⁷ / ₈ " D (556)
Interior Capacity	1.2 cu ft (34 L)
Interior Dimensions	17 ⁵ / ₁₆ " W (440) x 7 ¹ / ₈ " H (181) x 16 ⁹ / ₁₆ " D (421)
Power	950 W
Shipping Weight	96 lbs (44 kg)

FEATURES

- Stainless steel
- Standard or flush inset installation

Accessories

DESCRIPTION	NUMBER	MSRP
Flush Inset Vent	822114	\$40

Microwave Ovens

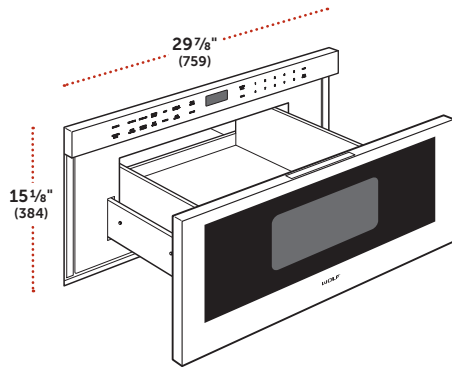

30" Professional Drawer Microwave Oven

MODEL	MSRP
MD30PE/S	\$2,105

SPECIFICATIONS

Overall Dimensions	29 7/8" W (759) x 15 1/8" H (384) x 21 7/8" D (556)
Interior Capacity	1.2 cu ft (34 L)
Interior Dimensions	17 5/16" W (440) x 7 1/8" H (181) x 16 9/16" D (421)
Power	950 W
Shipping Weight	96 lbs (44 kg)

FEATURES

- Stainless steel
- Standard or flush inset installation

Accessories

DESCRIPTION	NUMBER	MSRP
Flush Inset Vent	822114	\$40

Microwave Ovens

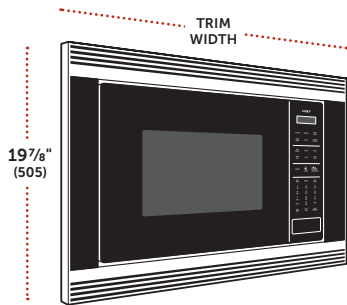

24" Convection Microwave Oven

MODEL	MSRP
MC24	\$1,085

SPECIFICATIONS

Freestanding Dims	24 ³ / ₄ "W (629) x 14 ⁷ / ₈ "H (378) x 20 ¹ / ₈ "D (511)
Interior Capacity	1.5 cu ft (42 L)
Interior Dimensions	16 ¹ / ₈ "W (410) x 9 ⁵ / ₈ "H (244) x 16 ¹ / ₈ "D (410)
Power	900 W
Shipping Weight	68 lbs (31 kg)

FEATURES

- Built-in with trim or freestanding
- Stainless steel trim to match Wolf ovens
- Convection with 3 cooking modes

Trim Kits

DESCRIPTION	NUMBER	MSRP
M Series Contemporary Trim		
30" (762) Black Glass	824643	\$450
NEW 30" (762) Stainless Steel*	829306	\$450
M Series Stainless Steel Trim		
30" (762) Transitional*	827869	\$450
30" (762) Professional*	827869	\$450
E Series Trim		
27" (686) Black	820037	\$425
27" (686) Stainless	809960	\$425
NEW 30" (762) Transitional*	829306	\$450
30" (762) Professional*	827869	\$450

*Trims kits will support both E Series and M Series applications as listed.

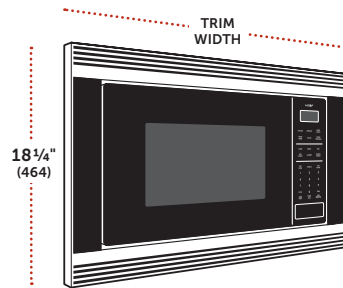

24" Standard Microwave Oven

MODEL	MSRP
MS24	\$835

SPECIFICATIONS

Freestanding Dims	24"W (610) x 13 ³ / ₈ "H (340) x 19 ¹ / ₈ "D (486)
Interior Capacity	2.0 cu ft (57 L)
Interior Dimensions	17 ³ / ₈ "W (441) x 10 ¹ / ₂ "H (267) x 18 ⁵ / ₈ "D (473)
Power	1200 W
Shipping Weight	50 lbs (23 kg)

FEATURES

- Built-in with trim or freestanding
- Stainless steel trim to match Wolf ovens

Trim Kits

DESCRIPTION	NUMBER	MSRP
M Series Contemporary Trim		
30" (762) Black Glass	824642	\$450
NEW 30" (762) Stainless Steel*	829310	\$450
M Series Stainless Steel Trim		
30" (762) Transitional*	827870	\$450
30" (762) Professional*	827870	\$450
E Series Trim		
27" (686) Black	820036	\$425
27" (686) Stainless	809959	\$425
NEW 30" (762) Transitional*	829310	\$450
30" (762) Professional*	827870	\$450

*Trims kits will support both E Series and M Series applications as listed.

Warming Drawer

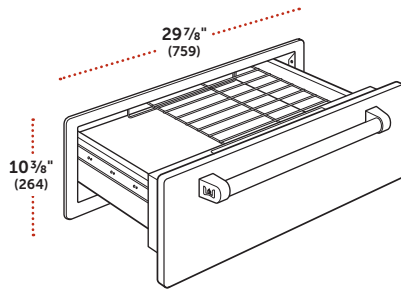

30" Warming Drawer

MODEL	MSRP
WWD30	\$2,185

SPECIFICATIONS

Overall Dimensions	29 7/8" W (759) x 10 3/8" H (264) x 22 3/4" D (578)
Interior Capacity	1.6 cu ft (45 L)
Interior Dimensions	25" W (635) x 6" H (152) x 18" D (457)
Heating Element	850 W
Shipping Weight	100 lbs (45 kg)

FEATURES

- Stainless steel
- Drawer fronts to match Wolf ovens (drawer front required)
- Drawer fronts to match sealed burner rangetop

Accessories

DESCRIPTION	NUMBER	MSRP
M Series Drawer Fronts		
30" Transitional	823278	\$450
30" Professional	823279	\$450
30" Contemporary Black	823277	\$450
30" Contemporary Stainless	826754	\$450
M Series Handles		
Transitional	826011	\$180
Professional	826012	\$180
Contemporary	826544	\$180
E Series Drawer Fronts		
NEW 30" Transitional	829839	\$450
NEW 30" Professional	829837	\$450
E Series Handles		
NEW Transitional	829298	\$180
NEW Professional	829299	\$180
Integrated Drawer Front		
Integrated Drawer Front	808152	\$70
2" Thick Pro Drawer Fronts*		
30" Professional	812601	\$460
36" Professional	812602	\$460
6-pc Container Set	808529	\$430

*2" (51) thick panel to match depth of sealed burner rangetop.

Coffee System

Coffee System

No need to run out to the corner coffee shop—enjoy professional-quality brewed coffee, espresso, cappuccino, and more in the comfort of your home. The Wolf Coffee System lets you craft a cup precisely to your taste, from real coffee beans, with the touch of a button. Installs anywhere in your home or office—no plumbing required.

MODEL NUMBER KEY

Coffee System	EC
Black Glass	B

Coffee System

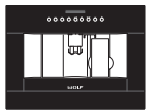

EC24/B

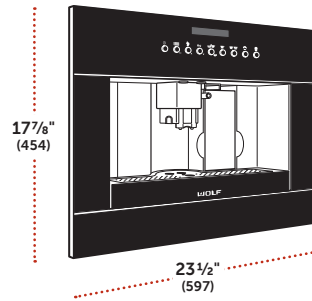

24" Coffee System / Black

MODEL	MSRP
EC24/B	\$3,560

SPECIFICATIONS

Overall Dimensions	23 1/2" W (597) x 17 7/8" H (454) x 15 1/2" D (394)
Shipping Weight	80 lbs (36 kg)

FEATURES

- Built-in with trim kits to match Wolf ovens

Accessories

DESCRIPTION	NUMBER	MSRP
Descaling Solution (2)	829244	\$20
Care Kit	824768	\$90

30" (762) Trim Kits

DESCRIPTION	NUMBER	MSRP
Vertical, Single or Horizontal Installation		
Contemporary	826197	\$190
Vertical or Single Installation		
M Series Transitional	826405	\$210
M Series Professional	826407	\$210
E Series Transitional	826406	\$260
NEW E Series Professional	829806	\$260
Horizontal Installation		
M Series Transitional	826401	\$210
M Series Professional	826403	\$210
E Series Transitional	826402	\$260
NEW E Series Professional	829302	\$260

Ranges

Delight at precise control born through decades of engineering prowess with Wolf Ranges. Home chefs will enjoy the power and finesse of professional kitchen appliances, knowing they can always create the dishes they have in mind with Wolf. On Dual Fuel, you can customize your cooking surface with a combination of burners, infrared charbroiler, infrared griddle, or French top. Find the right fit for your kitchen with a wide range of sizes and performance-enhancing features.

MODEL NUMBER KEY

Induction Range	IR
Dual Fuel Range	DF
Infrared Griddle	G
Infrared Double Griddle	DG
Infrared Charbroiler	C
French Top	F
Stainless Steel	S
Tubular Handle	T
Pro Handle	P
LP Gas	LP

Induction Ranges

30" RANGE



IR30450/S/T

36" RANGE



IR36550/S/T

Dual Fuel Ranges

30" RANGE

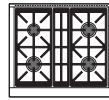

DF30450/S/P

48" RANGES

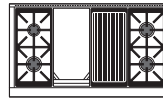

DF48450CG/S/P

60" RANGES

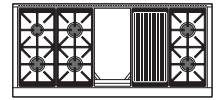

DF60650CG/S/P

36" RANGES

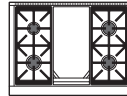

DF36450G/S/P

DF48650C/S/P

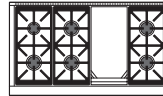

DF48650G/S/P

DF60650DG/S/P

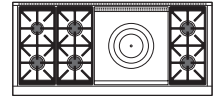

DF60650F/S/P

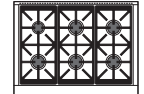

DF36650/S/P

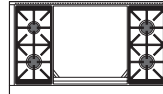

DF48450DG/S/P

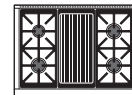

DF36450C/S/P

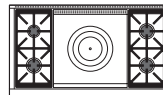

DF48450F/S/P

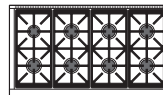

DF48850/S/P

Induction Ranges

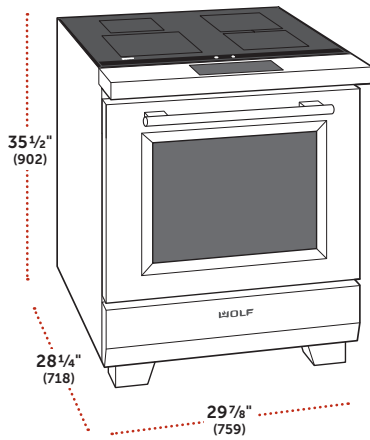

30" Transitional Induction Range

MODEL	MSRP
IR30450/S/T	\$7,950

SPECIFICATIONS

Overall Dimensions	29 7/8" W (759) x 35 1/2" H (902) x 28 1/4" D (718)
Element Diameter	Max Element Power
11" (279)	2600 W with 3700 W boost
(2) 8" (203)	2100 W with 3700 W boost
6" (152)	1400 W with 2200 W boost
Cooktop Max Power Output	7400 W
Oven Capacity	5.1 cu ft (144 L)
Interior Dimensions	25 1/4" W (641) x 17 1/2" H (445) x 20" D (508)
Shipping Weight	391 lbs (177 kg)

FEATURES

- Scratch-resistant, ceramic glass induction cooking surface
- Dual VertiCross™ convection oven with 10 cooking modes including Gourmet
- Large full-color touch screen
- True simmer and melt settings
- Boost Mode delivers rapid heat for faster boil times
- Bridge function joins two induction zones
- 1 standard and 2 full-extension ball bearing racks
- Broiler pan and temperature probe

Accessories

Surface Accessories

DESCRIPTION	NUMBER	MSRP
Filler Trim (2-pc)	9022633	\$90

Oven Accessories

DESCRIPTION	NUMBER	MSRP
Full-Ext Ball-Bearing Rack	9030652	\$170
Standard Oven Rack	823256	\$80
30" (762) Baking Sheet	823269	\$70
Temperature Probe	823261	\$70
Broiler Pan	819377	\$60
Dehydration Kit	9034725	\$180
Bake Stone Kit	9016697	\$230

Leg Extension Covers, Caster Covers and Kickplate

DESCRIPTION	NUMBER	MSRP
Front Leg Extension Covers		
2 1/2" (64) Covers	9022347	\$70
3 1/2" (89) Covers	9022607	\$70
4" (102) Covers	9022608	\$70
4 1/2" (114) Covers	9022609	\$70
Rear Caster Covers		
2 1/2" (64) Covers	9022587	\$100
3" (76) Covers	9022588	\$100
3 1/2" (89) Covers	9022589	\$100
4" (102) Covers	9022590	\$100
4 1/2" (114) Covers	9022591	\$100
Kickplates		
2 1/2" (64) Stainless Steel	9022087	\$20
3" (76) Stainless Steel	9018542	\$20
3 1/2" (89) Stainless Steel	9022088	\$20
4" (102) Stainless Steel	9022089	\$20
4 1/2" (114) Stainless Steel	9022090	\$20

Use 2 1/2" (64) for countertop heights ranging from 35 1/2" (902) to 36" (914).
 Use 3" (76) for countertop heights ranging from 35 3/4" (908) to 36 1/2" (927).
 Use 3 1/2" (89) for countertop heights ranging from 36 1/4" (921) to 37" (940).
 Use 4" (102) for countertop heights ranging from 36 3/4" (934) to 37 1/2" (953).
 Use 4 1/2" (114) for countertop heights ranging from 37 1/4" (946) to 38" (965).

Induction Ranges

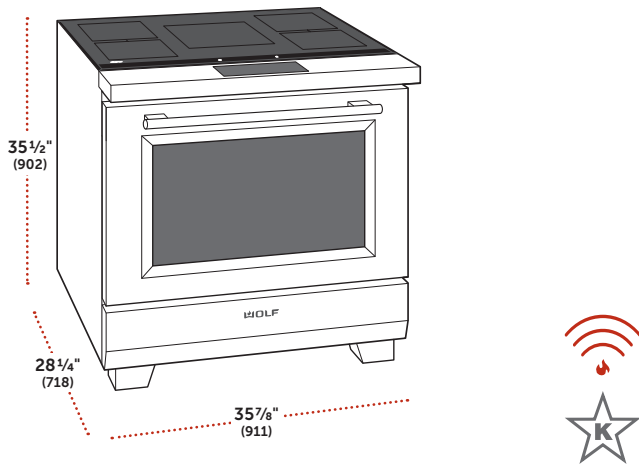

36" Transitional Induction Range

MODEL	MSRP
IR36550/S/T	\$10,950

SPECIFICATIONS

Overall Dimensions	35 ⁷ / ₈ " W (911) x 35 ¹ / ₂ " H (902) x 28 ¹ / ₄ " D (718)
Element Diameter	Max Element Power
11" (279)	2600 W with 3700 W boost
(4) 8" (203)	2100 W with 3700 W boost
Cooktop Max Power Output	11,100 W
Oven Capacity	6.3 cu ft (178 L)
Interior Dimensions	31 ¹ / ₄ " W (794) x 17 ¹ / ₂ " H (445) x 20" D (508)
Shipping Weight	445 lbs (202 kg)

FEATURES

- Scratch-resistant, ceramic glass induction cooking surface
- Dual VertiCross™ convection oven with 10 cooking modes including Gourmet
- Large full-color touch screen
- True simmer and melt settings
- Boost Mode delivers rapid heat for faster boil times
- Bridge function joins two induction zones
- 1 standard and 2 full-extension ball bearing racks
- Broiler pan and temperature probe

Accessories

Surface Accessories

DESCRIPTION	NUMBER	MSRP
Filler Trim (2-pc)	9022633	\$90

Oven Accessories

DESCRIPTION	NUMBER	MSRP
Full-Ext Ball-Bearing Rack	9022538	\$170
Standard Oven Rack	9022540	\$80
Temperature Probe	823261	\$70
Broiler Pan	819377	\$60
Dehydration Kit	9034726	\$180
Bake Stone Kit	9016697	\$230

Leg Extension Covers, Caster Covers and Kickplate

DESCRIPTION	NUMBER	MSRP
Front Leg Extension Covers		
2 ¹ / ₂ " (64) Covers	9022347	\$70
3 ¹ / ₂ " (89) Covers	9022607	\$70
4" (102) Covers	9022608	\$70
4 ¹ / ₂ " (114) Covers	9022609	\$70
Rear Caster Covers		
2 ¹ / ₂ " (64) Covers	9022587	\$100
3" (76) Covers	9022588	\$100
3 ¹ / ₂ " (89) Covers	9022589	\$100
4" (102) Covers	9022590	\$100
4 ¹ / ₂ " (114) Covers	9022591	\$100
Kickplates		
2 ¹ / ₂ " (64) Stainless Steel	9022091	\$30
3" (76) Stainless Steel	9018543	\$30
3 ¹ / ₂ " (89) Stainless Steel	9022092	\$30
4" (102) Stainless Steel	9022093	\$30
4 ¹ / ₂ " (114) Stainless Steel	9022094	\$30

Use 2¹/₂" (64) for countertop heights ranging from 35¹/₂" (902) to 36" (914).
 Use 3" (76) for countertop heights ranging from 35³/₄" (908) to 36¹/₂" (927).
 Use 3¹/₂" (89) for countertop heights ranging from 36¹/₄" (921) to 37" (940).
 Use 4" (102) for countertop heights ranging from 36³/₄" (934) to 37¹/₂" (953).
 Use 4¹/₂" (114) for countertop heights ranging from 37¹/₄" (946) to 38" (965).

Dual Fuel Ranges

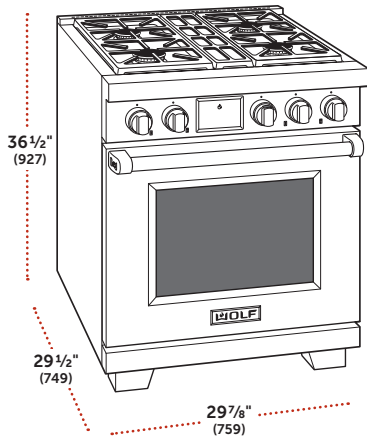

30" Dual Fuel Range



Model DF30450

MODEL	MSRP
DF30450/S/P	\$7,475
DF30450/S/P/LP	\$7,475

Red knobs and stainless steel bezels included with the range. Black or stainless steel knobs available at no charge with product purchase.

SPECIFICATIONS

Overall Dimensions	29 ⁷ / ₈ "W (759) x 36 ¹ / ₂ "H (927) x 29 ¹ / ₂ "D (749)
Surface Burners	20,000, 18,000, 15,000 and 9,200 Btu
Oven Capacity	5.1 cu ft (144 L)
Interior Dimensions	25 ¹ / ₄ "W (641) x 17 ¹ / ₂ "H (445) x 20"D (508)
Shipping Weight	413 lbs (187 kg)

FEATURES

- Dual-stacked, sealed burners
- Dual VertiCross™ convection oven with 10 cooking modes including Gourmet
- Large full-color touch screen
- Low Btu for true simmer and melts
- LED backlit control knobs
- 1 standard and 2 full-extension ball bearing racks
- Broiler pan and temperature probe
- Signature red knobs included

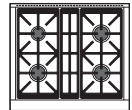

Dual Fuel Ranges

30" Dual Fuel Range Accessories

Stainless Steel Risers

DESCRIPTION	NUMBER	MSRP
Stainless Steel Risers*		
5" (127) Riser	9016116	\$230
10" (254) Riser	9016117	\$280
20" (508) Riser with Shelf	9016118	\$530

*Minimum 5" (127) riser required against combustible surfaces.

Knobs

DESCRIPTION	NUMBER	MSRP
Knobs		
Stainless Steel Knobs	9015761	\$170
Stainless Steel Knobs*	828438	N/C
Red Knobs	9039689	\$170
Black Knobs	9015758	\$170
Black Knobs*	828443	N/C

*One set at no charge with product purchase.

Surface Accessories

DESCRIPTION	NUMBER	MSRP
Filler Trim (2-pc)	810919	\$160
2-Burner Wok Grate*	9029243	\$90

*Grate covers two burner positions allowing one burner to accommodate a rounded wok.

Oven Accessories

DESCRIPTION	NUMBER	MSRP
Full-Ext Ball-Bearing Rack	9030652	\$170
Standard Oven Rack	823256	\$80
30" (762) Baking Sheet	823269	\$70
Temperature Probe	823261	\$70
Broiler Pan	819377	\$60
Dehydration Kit	9034725	\$180
Bake Stone Kit	9016697	\$230

Leg Extension Covers, Caster Covers and Kickplate

DESCRIPTION	NUMBER	MSRP
Front Leg Extension Covers		
2½" (64) Covers	9022347	\$70
3½" (89) Covers	9022607	\$70
4" (102) Covers	9022608	\$70
4½" (114) Covers	9022609	\$70
Rear Caster Covers		
2½" (64) Covers	9022587	\$100
3" (76) Covers	9022588	\$100
3½" (89) Covers	9022589	\$100
4" (102) Covers	9022590	\$100
4½" (114) Covers	9022591	\$100
Kickplates		
2½" (64) Stainless Steel	9022087	\$20
3" (76) Stainless Steel	9018542	\$20
3½" (89) Stainless Steel	9022088	\$20
4" (102) Stainless Steel	9022089	\$20
4½" (114) Stainless Steel	9022090	\$20

Use 2½" (64) for countertop heights ranging from 35½" (902) to 36" (914).
 Use 3" (76) for countertop heights ranging from 35¾" (908) to 36½" (927).
 Use 3½" (89) for countertop heights ranging from 36¼" (921) to 37" (940).
 Use 4" (102) for countertop heights ranging from 36¾" (934) to 37½" (953).
 Use 4½" (114) for countertop heights ranging from 37¼" (946) to 38" (965).

High Altitude Conversion Kit

DESCRIPTION	NUMBER	MSRP
LP Gas High Altitude Kit*	829280	\$60

*For installations above 8,600' (2621 m). For natural gas installations above 10,250' (3124 m), contact Wolf customer care.

Dual Fuel Ranges

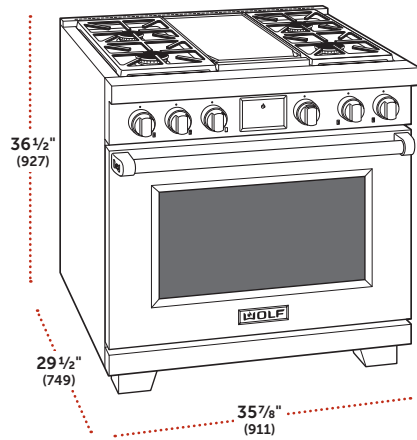

36" Dual Fuel Ranges

Model DF36450G

MODEL	MSRP
DF36450G/S/P	\$11,385
DF36450G/S/P/LP	\$11,385

Red knobs and stainless steel bezels included with the range. Black or stainless steel knobs available at no charge with product purchase.

SPECIFICATIONS

Overall Dimensions	35 7/8" W (911) x 36 1/2" H (927) x 29 1/2" D (749)
Surface Burners	20,000, 18,000, 15,000 and 9,200 Btu
Infrared Griddle	15,000 Btu (13,000 Btu LP)
Oven Capacity	6.3 cu ft (178 L)
Interior Dimensions	31 1/4" W (794) x 17 1/2" H (445) x 20" D (508)
Shipping Weight	503 lbs (228 kg)

FEATURES

- Dual-stacked, sealed burners
- Dual VertiCross™ convection oven with 10 cooking modes including Gourmet
- Adjustable infrared griddle
- Large full-color touch screen
- Low Btu for true simmer and melts
- LED backlit control knobs
- 1 standard and 2 full-extension ball bearing racks
- Broiler pan and temperature probe
- Signature red knobs included

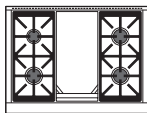

Model DF36650

MODEL	MSRP
DF36650/S/P	\$10,535
DF36650/S/P/LP	\$10,535

Red knobs and stainless steel bezels included with the range. Black or stainless steel knobs available at no charge with product purchase.

SPECIFICATIONS

Overall Dimensions	35 7/8" W (911) x 36 1/2" H (927) x 29 1/2" D (749)
Surface Burners	20,000, (2) 18,000, (2) 15,000 and 9,200 Btu
Oven Capacity	6.3 cu ft (178 L)
Interior Dimensions	31 1/4" W (794) x 17 1/2" H (445) x 20" D (508)
Shipping Weight	471 lbs (214 kg)

FEATURES

- Dual-stacked, sealed burners
- Dual VertiCross™ convection oven with 10 cooking modes including Gourmet
- Large full-color touch screen
- Low Btu for true simmer and melts
- LED backlit control knobs
- 1 standard and 2 full-extension ball bearing racks
- Broiler pan and temperature probe
- Signature red knobs included

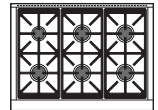

Model DF36450C

MODEL	MSRP
DF36450C/S/P	\$11,385
DF36450C/S/P/LP	\$11,385

Red knobs and stainless steel bezels included with the range. Black or stainless steel knobs available at no charge with product purchase.

SPECIFICATIONS

Overall Dimensions	35 7/8" W (911) x 36 1/2" H (927) x 29 1/2" D (749)
Surface Burners	20,000, 18,000, 15,000 and 9,200 Btu
Infrared Charbroiler	16,000 Btu
Oven Capacity	6.3 cu ft (178 L)
Interior Dimensions	31 1/4" W (794) x 17 1/2" H (445) x 20" D (508)
Shipping Weight	482 lbs (219 kg)

FEATURES

- Dual-stacked, sealed burners
- Dual VertiCross™ convection oven with 10 cooking modes including Gourmet
- Adjustable infrared charbroiler
- Large full-color touch screen
- Low Btu for true simmer and melts
- LED backlit control knobs
- 1 standard and 2 full-extension ball bearing racks
- Broiler pan and temperature probe
- Signature red knobs included

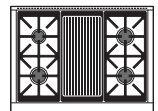

Dual Fuel Ranges

36" Dual Fuel Range Accessories

Stainless Steel Risers

DESCRIPTION	NUMBER	MSRP
Stainless Steel Risers*		
5" (127) Riser	9016119	\$250
10" (254) Riser	9016120	\$300
20" (508) Riser with Shelf	9016121	\$600

*Minimum 10" (254) riser required against combustible surfaces.

Knobs

DESCRIPTION	NUMBER	MSRP
Knobs		
Stainless Steel Knobs	9015762	\$170
Stainless Steel Knobs*	828439	N/C
Red Knobs	9039690	\$170
Black Knobs	9015759	\$170
Black Knobs*	828442	N/C

*One set at no charge with product purchase.

Surface Accessories

DESCRIPTION	NUMBER	MSRP
Filler Trim (2-pc)	810919	\$160
2-Burner Wok Grate*	9029243	\$90
Griddle Model		
11" (279) Cutting Board	9022536	\$110
Griddle Cleaning Kit	812278	\$190
Cleaning Solution (4) 1-qt	812279	\$110
Cleaning Pads (6) 10-packs	812280	\$125

*Grate covers two burner positions allowing one burner to accommodate a rounded wok.

Oven Accessories

DESCRIPTION	NUMBER	MSRP
Full-Ext Ball-Bearing Rack	9022538	\$170
Standard Oven Rack	9022540	\$80
Temperature Probe	823261	\$70
Broiler Pan	819377	\$60
Dehydration Kit	9034726	\$180
Bake Stone Kit	9016697	\$230

Leg Extension Covers, Caster Covers and Kickplate

DESCRIPTION	NUMBER	MSRP
Front Leg Extension Covers		
2½" (64) Covers	9022347	\$70
3½" (89) Covers	9022607	\$70
4" (102) Covers	9022608	\$70
4½" (114) Covers	9022609	\$70
Rear Caster Covers		
2½" (64) Covers	9022587	\$100
3" (76) Covers	9022588	\$100
3½" (89) Covers	9022589	\$100
4" (102) Covers	9022590	\$100
4½" (114) Covers	9022591	\$100
Kickplates		
2½" (64) Stainless Steel	9022091	\$30
3" (76) Stainless Steel	9018543	\$30
3½" (89) Stainless Steel	9022092	\$30
4" (102) Stainless Steel	9022093	\$30
4½" (114) Stainless Steel	9022094	\$30

Use 2½" (64) for countertop heights ranging from 35½" (902) to 36" (914).
 Use 3" (76) for countertop heights ranging from 35¾" (908) to 36½" (927).
 Use 3½" (89) for countertop heights ranging from 36¼" (921) to 37" (940).
 Use 4" (102) for countertop heights ranging from 36¾" (934) to 37½" (953).
 Use 4½" (114) for countertop heights ranging from 37¼" (946) to 38" (965).

High Altitude Conversion Kit

DESCRIPTION	NUMBER	MSRP
LP Gas High Altitude Kit*	829280	\$60

*For installations above 8,600' (2621 m). For natural gas installations above 10,250' (3124 m), contact Wolf customer care.

Dual Fuel Ranges

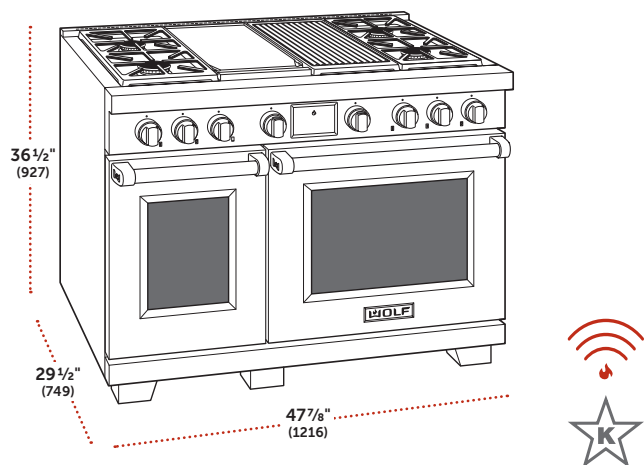

48" Dual Fuel Ranges

Model DF48450CG

MODEL	MSRP
DF48450CG/S/P	\$15,645
DF48450CG/S/P/LP	\$15,645

Red knobs and stainless steel bezels included with the range. Black or stainless steel knobs available at no charge with product purchase.

SPECIFICATIONS

Overall Dimensions	47 ⁷ / ₈ " W (1216) x 36 ¹ / ₂ " H (927) x 29 ¹ / ₂ " D (749)
Surface Burners	20,000, 18,000, 15,000 and 9,200 Btu
Infrared Griddle	15,000 Btu (13,000 Btu LP)
Infrared Charbroiler	16,000 Btu
30" Oven Capacity	5.1 cu ft (144 L)
Interior Dimensions	25 ¹ / ₄ " W (641) x 17 ¹ / ₂ " H (445) x 20" D (508)
18" Oven Capacity	1.8 cu ft (51 L)
Interior Dimensions	13 ¹ / ₄ " W (337) x 17 ¹ / ₂ " H (445) x 20" D (508)
Shipping Weight	704 lbs (319 kg)

FEATURES

- Dual-stacked, sealed burners
- Large Dual VertiCross™ convection oven with 10 cooking modes including Gourmet, and 18" single convection oven with 9 cooking modes
- Adjustable infrared griddle
- Adjustable infrared charbroiler
- Large full-color touch screen
- Low Btu for true simmer and melts
- LED backlit control knobs
- 1 standard and 2 full-extension ball bearing racks in the 30" oven
- 1 standard and 1 full-extension ball bearing racks in the 18" oven
- Broiler pan and temperature probe
- Signature red knobs included

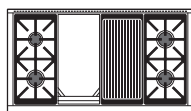

Model DF48850

MODEL	MSRP
DF48850/S/P	\$13,945
DF48850/S/P/LP	\$13,945

Red knobs and stainless steel bezels included with the range. Black or stainless steel knobs available at no charge with product purchase.

SPECIFICATIONS

Overall Dimensions	47 ⁷ / ₈ " W (1216) x 36 ¹ / ₂ " H (927) x 29 ¹ / ₂ " D (749)
Surface Burners	20,000, (3) 18,000, (3) 15,000 and 9,200 Btu
30" Oven Capacity	5.1 cu ft (144 L)
Interior Dimensions	25 ¹ / ₄ " W (641) x 17 ¹ / ₂ " H (445) x 20" D (508)
18" Oven Capacity	1.8 cu ft (51 L)
Interior Dimensions	13 ¹ / ₄ " W (337) x 17 ¹ / ₂ " H (445) x 20" D (508)
Shipping Weight	657 lbs (298 kg)

FEATURES

- Dual-stacked, sealed burners
- Large Dual VertiCross™ convection oven with 10 cooking modes including Gourmet, and 18" single convection oven with 9 cooking modes
- Large full-color touch screen
- Low Btu for true simmer and melts
- LED backlit control knobs
- 1 standard and 2 full-extension ball bearing racks in the 30" oven
- 1 standard and 1 full-extension ball bearing racks in the 18" oven
- Broiler pan and temperature probe
- Signature red knobs included

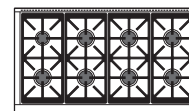

Dual Fuel Ranges

48" Dual Fuel Ranges

Model DF48650C

MODEL	MSRP
DF48650C/S/P	\$14,795
DF48650C/S/P/LP	\$14,795

Red knobs and stainless steel bezels included with the range. Black or stainless steel knobs available at no charge with product purchase.

SPECIFICATIONS

Overall Dimensions	47 ⁷ / ₈ "W (1216) x 36 ¹ / ₂ "H (927) x 29 ¹ / ₂ "D (749)
Surface Burners	20,000, (2) 18,000, (2) 15,000 and 9,200 Btu
Infrared Charbroiler	16,000 Btu
30" Oven Capacity	5.1 cu ft (144 L)
Interior Dimensions	25 ¹ / ₄ "W (641) x 17 ¹ / ₂ "H (445) x 20"D (508)
18" Oven Capacity	1.8 cu ft (51 L)
Interior Dimensions	13 ¹ / ₄ "W (337) x 17 ¹ / ₂ "H (445) x 20"D (508)
Shipping Weight	672 lbs (305 kg)

FEATURES

- Dual-stacked, sealed burners
- Large Dual VertiCross™ convection oven with 10 cooking modes including Gourmet, and 18" single convection oven with 9 cooking modes
- Adjustable infrared charbroiler
- Large full-color touch screen
- Low Btu for true simmer and melts
- LED backlit control knobs
- 1 standard and 2 full-extension ball bearing racks in the 30" oven
- 1 standard and 1 full-extension ball bearing racks in the 18" oven
- Broiler pan and temperature probe
- Signature red knobs included

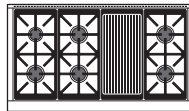

Model DF48650G

MODEL	MSRP
DF48650G/S/P	\$14,795
DF48650G/S/P/LP	\$14,795

Red knobs and stainless steel bezels included with the range. Black or stainless steel knobs available at no charge with product purchase.

SPECIFICATIONS

Overall Dimensions	47 ⁷ / ₈ "W (1216) x 36 ¹ / ₂ "H (927) x 29 ¹ / ₂ "D (749)
Surface Burners	20,000, (2) 18,000, (2) 15,000 and 9,200 Btu
Infrared Griddle	15,000 Btu (13,000 Btu LP)
30" Oven Capacity	5.1 cu ft (144 L)
Interior Dimensions	25 ¹ / ₄ "W (641) x 17 ¹ / ₂ "H (445) x 20"D (508)
18" Oven Capacity	1.8 cu ft (51 L)
Interior Dimensions	13 ¹ / ₄ "W (337) x 17 ¹ / ₂ "H (445) x 20"D (508)
Shipping Weight	692 lbs (314 kg)

FEATURES

- Dual-stacked, sealed burners
- Large Dual VertiCross™ convection oven with 10 cooking modes including Gourmet, and 18" single convection oven with 9 cooking modes
- Adjustable infrared griddle
- Large full-color touch screen
- Low Btu for true simmer and melts
- LED backlit control knobs
- 1 standard and 2 full-extension ball bearing racks in the 30" oven
- 1 standard and 1 full-extension ball bearing racks in the 18" oven
- Broiler pan and temperature probe
- Signature red knobs included

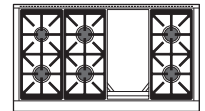

Dual Fuel Ranges

48" Dual Fuel Ranges

Model DF48450DG

MODEL	MSRP
DF48450DG/S/P	\$15,645
DF48450DG/S/P/LP	\$15,645

Red knobs and stainless steel bezels included with the range. Black or stainless steel knobs available at no charge with product purchase.

SPECIFICATIONS

Overall Dimensions	47 ⁷ / ₈ "W (1216) x 36 ¹ / ₂ "H (927) x 29 ¹ / ₂ "D (749)
Surface Burners	20,000, 18,000, 15,000 and 9,200 Btu
Double Griddle	(2) 15,000 Btu (13,000 Btu LP)
30" Oven Capacity	5.1 cu ft (144 L)
Interior Dimensions	25 ¹ / ₄ "W (641) x 17 ¹ / ₂ "H (445) x 20"D (508)
18" Oven Capacity	1.8 cu ft (51 L)
Interior Dimensions	13 ¹ / ₄ "W (337) x 17 ¹ / ₂ "H (445) x 20"D (508)
Shipping Weight	708 lbs (321 kg)

FEATURES

- Dual-stacked, sealed burners
- Large Dual VertiCross™ convection oven with 10 cooking modes including Gourmet, and 18" single convection oven with 9 cooking modes
- Adjustable double infrared griddle
- Large full-color touch screen
- Low Btu for true simmer and melts
- LED backlit control knobs
- 1 standard and 2 full-extension ball bearing racks in the 30" oven
- 1 standard and 1 full-extension ball bearing racks in the 18" oven
- Broiler pan and temperature probe
- Signature red knobs included

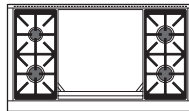

Model DF48450F

MODEL	MSRP
DF48450F/S/P	\$16,225
DF48450F/S/P/LP	\$16,225

Red knobs and stainless steel bezels included with the range. Black or stainless steel knobs available at no charge with product purchase.

SPECIFICATIONS

Overall Dimensions	47 ⁷ / ₈ "W (1216) x 36 ¹ / ₂ "H (927) x 29 ¹ / ₂ "D (749)
Surface Burners	20,000, 18,000, 15,000 and 9,200 Btu
French Top	15,000 Btu
30" Oven Capacity	5.1 cu ft (144 L)
Interior Dimensions	25 ¹ / ₄ "W (641) x 17 ¹ / ₂ "H (445) x 20"D (508)
18" Oven Capacity	1.8 cu ft (51 L)
Interior Dimensions	13 ¹ / ₄ "W (337) x 17 ¹ / ₂ "H (445) x 20"D (508)
Shipping Weight	695 lbs (315 kg)

FEATURES

- Dual-stacked, sealed burners
- Large Dual VertiCross™ convection oven with 10 cooking modes including Gourmet, and 18" single convection oven with 9 cooking modes
- French top
- Large full-color touch screen
- Low Btu for true simmer and melts
- LED backlit control knobs
- 1 standard and 2 full-extension ball bearing racks in the 30" oven
- 1 standard and 1 full-extension ball bearing racks in the 18" oven
- Broiler pan and temperature probe
- Signature red knobs included

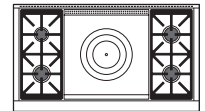

Dual Fuel Ranges

48" Dual Fuel Range Accessories

Stainless Steel Risers

DESCRIPTION	NUMBER	MSRP
Stainless Steel Risers*		
5" (127) Riser	9016122	\$280
10" (254) Riser	9016123	\$350
20" (508) Riser with Shelf	9016124	\$730

*Minimum 10" (254) riser required against combustible surfaces.

Knobs

DESCRIPTION	NUMBER	MSRP
Knobs		
Stainless Steel Knobs	9015763	\$170
Stainless Steel Knobs*	828440	N/C
Red Knobs	9039691	\$170
Black Knobs	9015760	\$170
Black Knobs*	828441	N/C

*One set at no charge with product purchase.

Surface Accessories

DESCRIPTION	NUMBER	MSRP
Filler Trim (2-pc)	810919	\$160
2-Burner Wok Grate*	9029243	\$90
Griddle Models		
11" (279) Cutting Board	9022536	\$110
22" (559) Cutting Board	9022537	\$125
Griddle Cleaning Kit	812278	\$190
Cleaning Solution (4) 1-qt	812279	\$110
Cleaning Pads (6) 10-packs	812280	\$125

*Grate covers two burner positions allowing one burner to accommodate a rounded wok.

Oven Accessories

DESCRIPTION	NUMBER	MSRP
30" Oven		
Full-Ext Ball-Bearing Rack	9030652	\$170
Standard Oven Rack	823256	\$80
30" (762) Baking Sheet	823269	\$70
Broiler Pan	819377	\$60
Dehydration Kit	9034725	\$180
Bake Stone Kit	9016697	\$230
18" Oven		
Full-Ext Ball-Bearing Rack	9022539	\$125
Standard Oven Rack	9022541	\$40
Broiler Pan	819376	\$60
Dehydration Kit	9034727	\$160
Temperature Probe	823261	\$70

Leg Extension Covers, Caster Covers and Kickplate

DESCRIPTION	NUMBER	MSRP
Front Leg Extension Covers		
2½" (64) Covers	9022347	\$70
3½" (89) Covers	9022607	\$70
4" (102) Covers	9022608	\$70
4½" (114) Covers	9022609	\$70
Rear Caster Covers		
2½" (64) Covers	9022587	\$100
3" (76) Covers	9022588	\$100
3½" (89) Covers	9022589	\$100
4" (102) Covers	9022590	\$100
4½" (114) Covers	9022591	\$100
Kickplates		
2½" (64) Stainless Steel	9022113	\$40
3" (76) Stainless Steel	9018545	\$40
3½" (89) Stainless Steel	9022114	\$40
4" (102) Stainless Steel	9022115	\$40
4½" (114) Stainless Steel	9022116	\$40

Use 2½" (64) for countertop heights ranging from 35½" (902) to 36" (914).
 Use 3" (76) for countertop heights ranging from 35¾" (908) to 36½" (927).
 Use 3½" (89) for countertop heights ranging from 36¼" (921) to 37" (940).
 Use 4" (102) for countertop heights ranging from 36¾" (934) to 37½" (953).
 Use 4½" (114) for countertop heights ranging from 37¼" (946) to 38" (965).

High Altitude Conversion Kit

DESCRIPTION	NUMBER	MSRP
LP Gas High Altitude Kit*	829280	\$60

*For installations above 8,600' (2621 m). For natural gas installations above 10,250' (3124 m), contact Wolf customer care.

Dual Fuel Ranges

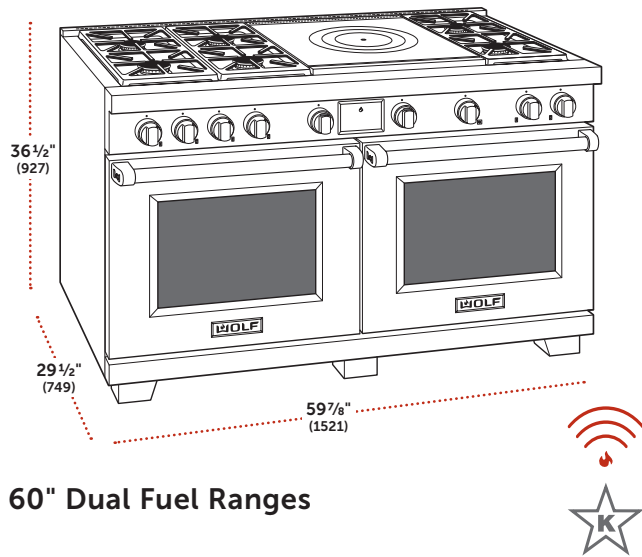

60" Dual Fuel Ranges

Model DF60650F

MODEL	MSRP
DF60650F/S/P	\$19,860
DF60650F/S/P/LP	\$19,860

Red knobs and stainless steel bezels included with the range. Black or stainless steel knobs available at no charge with product purchase.

SPECIFICATIONS

Overall Dimensions	59 7/8" W (1521) x 36 1/2" H (927) x 29 1/2" D (749)
Surface Burners	20,000, (2) 18,000, (2) 15,000 and 9,200 Btu
French Top	15,000 Btu
Capacity (per oven)	5.1 cu ft (144 L)
Interior Dimensions	25 1/4" W (641) x 17 1/2" H (445) x 20" D (508)
Shipping Weight	799 lbs (362 kg)

FEATURES

- Dual-stacked, sealed burners
- Dual VertiCross™ convection ovens with 10 cooking modes including Gourmet
- French top
- Large full-color touch screen
- Low Btu for true simmer and melts
- LED backlit control knobs
- 1 standard and 2 full-extension ball bearing racks in the (per oven)
- Broiler pan and temperature probe
- Signature red knobs included

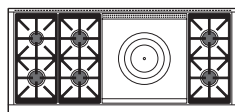

Model DF60650CG

MODEL	MSRP
DF60650CG/S/P	\$19,280
DF60650CG/S/P/LP	\$19,280

Red knobs and stainless steel bezels included with the range. Black or stainless steel knobs available at no charge with product purchase.

SPECIFICATIONS

Overall Dimensions	59 7/8" W (1521) x 36 1/2" H (927) x 29 1/2" D (749)
Surface Burners	20,000, (2) 18,000, (2) 15,000 and 9,200 Btu
Infrared Griddle	15,000 Btu (13,000 Btu LP)
Infrared Charbroiler	16,000 Btu
Capacity (per oven)	5.1 cu ft (144 L)
Interior Dimensions	25 1/4" W (641) x 17 1/2" H (445) x 20" D (508)
Shipping Weight	827 lbs (375 kg)

FEATURES

- Dual-stacked, sealed burners
- Dual VertiCross™ convection ovens with 10 cooking modes including Gourmet
- Adjustable infrared griddle
- Adjustable infrared charbroiler
- Large full-color touch screen
- Low Btu for true simmer and melts
- LED backlit control knobs
- 1 standard and 2 full-extension ball bearing racks in the (per oven)
- Broiler pan and temperature probe
- Signature red knobs included

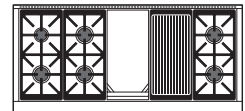

Dual Fuel Ranges

60" Dual Fuel Ranges

Model DF60650DG

MODEL	MSRP
DF60650DG/S/P	\$19,280
DF60650DG/S/P/LP	\$19,280

Red knobs and stainless steel bezels included with the range. Black or stainless steel knobs available at no charge with product purchase.

SPECIFICATIONS

Overall Dimensions	59 ⁷ / ₈ " W (1521) x 36 ¹ / ₂ " H (927) x 29 ¹ / ₂ " D (749)
Surface Burners	20,000, (2) 18,000, (2) 15,000 and 9,200 Btu
Double Griddle	(2) 15,000 Btu (13,000 Btu LP)
Capacity (per oven)	5.1 cu ft (144 L)
Interior Dimensions	25 ¹ / ₄ " W (641) x 17 ¹ / ₂ " H (445) x 20" D (508)
Shipping Weight	831 lbs (377 kg)

FEATURES

- Dual-stacked, sealed burners
- Dual VertiCross™ convection ovens with 10 cooking modes including Gourmet
- Adjustable double infrared griddle
- Large full-color touch screen
- Low Btu for true simmer and melts
- LED backlit control knobs
- 1 standard and 2 full-extension ball bearing racks in the (per oven)
- Broiler pan and temperature probe
- Signature red knobs included

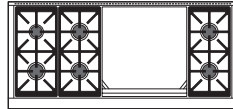

Dual Fuel Ranges

60" Dual Fuel Range Accessories

Stainless Steel Risers

DESCRIPTION	NUMBER	MSRP
Stainless Steel Risers*		
5" (127) Riser	9016125	\$360
10" (254) Riser	9016126	\$420
20" (508) Riser with Shelf	9016127	\$900

*Minimum 10" (254) riser required against combustible surfaces.

Knobs

DESCRIPTION	NUMBER	MSRP
Knobs		
Stainless Steel Knobs	9015763	\$170
Stainless Steel Knobs*	828440	N/C
Red Knobs	9039691	\$170
Black Knobs	9015760	\$170
Black Knobs*	828441	N/C

*One set at no charge with product purchase.

Surface Accessories

DESCRIPTION	NUMBER	MSRP
Filler Trim (2-pc)	810919	\$160
2-Burner Wok Grate*	9029243	\$90
Griddle Models		
11" (279) Cutting Board	9022536	\$110
22" (559) Cutting Board	9022537	\$125
Griddle Cleaning Kit	812278	\$190
Cleaning Solution (4) 1-qt	812279	\$110
Cleaning Pads (6) 10-packs	812280	\$125

*Grate covers two burner positions allowing one burner to accommodate a rounded wok.

Oven Accessories

DESCRIPTION	NUMBER	MSRP
Full-Ext Ball-Bearing Rack	9030652	\$170
Standard Oven Rack	823256	\$80
30" (762) Baking Sheet	823269	\$70
Temperature Probe	823261	\$70
Broiler Pan	819377	\$60
Dehydration Kit	9034725	\$180
Bake Stone Kit	9016697	\$230

Leg Extension Covers, Caster Covers and Kickplate

DESCRIPTION	NUMBER	MSRP
Front Leg Extension Covers		
2½" (64) Covers	9022347	\$70
3½" (89) Covers	9022607	\$70
4" (102) Covers	9022608	\$70
4½" (114) Covers	9022609	\$70
Rear Caster Covers		
2½" (64) Covers	9022587	\$100
3" (76) Covers	9022588	\$100
3½" (89) Covers	9022589	\$100
4" (102) Covers	9022590	\$100
4½" (114) Covers	9022591	\$100
Kickplates		
2½" (64) Stainless Steel	9022117	\$50
3" (76) Stainless Steel	9018546	\$50
3½" (89) Stainless Steel	9022118	\$50
4" (102) Stainless Steel	9022119	\$50
4½" (114) Stainless Steel	9022120	\$50

Use 2½" (64) for countertop heights ranging from 35½" (902) to 36" (914).
 Use 3" (76) for countertop heights ranging from 35¾" (908) to 36½" (927).
 Use 3½" (89) for countertop heights ranging from 36¼" (921) to 37" (940).
 Use 4" (102) for countertop heights ranging from 36¾" (934) to 37½" (953).
 Use 4½" (114) for countertop heights ranging from 37¼" (946) to 38" (965).

High Altitude Conversion Kit

DESCRIPTION	NUMBER	MSRP
LP Gas High Altitude Kit*	829280	\$60

*For installations above 8,600' (2621 m). For natural gas installations above 10,250' (3124 m), contact Wolf customer care.

This page intentionally left blank

This page intentionally left blank

Warranty Information

Wolf Appliance Residential Limited Warranty

FOR RESIDENTIAL USE

FULL TWO YEAR WARRANTY*

For two years from the date of original installation, this Wolf Appliance product warranty covers all parts and labor to repair or replace, under normal residential use, any part of the product that proves to be defective in materials or workmanship. All service provided by Wolf Appliance under the above warranty must be performed by Wolf Factory Certified Service, unless otherwise specified by Wolf Appliance, Inc. Service will be provided during normal business hours.

LIMITED FIVE YEAR WARRANTY

For five years from the date of original installation, Wolf Appliance will repair or replace the following parts that prove to be defective in materials or workmanship: gas burners (excludes appearance), electric heating elements, blower motors (ventilation hoods), electronic control boards, magnetron tubes and induction generators. If the owner uses Wolf Factory Certified Service, the service provider will repair or replace these parts with the owner paying for all other costs, including labor. If the owner uses non-certified service, the owner must contact Wolf Appliance, Inc. (using the information below) to receive repaired or replacement parts. Wolf Appliance will not reimburse the owner for parts purchased from non-certified service or other sources.

TERMS APPLICABLE TO EACH WARRANTY

The warranty applies only to products installed for normal residential use. The warranty applies only to products installed in any one of the fifty states of the United States, the District of Columbia or the ten provinces of Canada. This warranty does not cover any parts or labor to correct any defect caused by negligence, accident or improper use, maintenance, installation, service or repair.

THE REMEDIES DESCRIBED ABOVE FOR EACH WARRANTY ARE THE ONLY ONES THAT WOLF APPLIANCE, INC. WILL PROVIDE, EITHER UNDER THIS WARRANTY OR UNDER ANY WARRANTY ARISING BY OPERATION OF LAW. WOLF APPLIANCE, INC. WILL NOT BE RESPONSIBLE FOR ANY CONSEQUENTIAL OR INCIDENTAL DAMAGES ARISING FROM THE BREACH OF THIS WARRANTY OR ANY OTHER WARRANTY, WHETHER EXPRESS, IMPLIED OR STATUTORY.

Some states do not allow the exclusion or limitation of incidental or consequential damages, so the above limitation or exclusion may not apply to you. This warranty gives you specific legal rights and you may also have other legal rights that vary from state to state.

To receive parts and/or service and the name of Wolf Factory Certified Service nearest you, contact Wolf Appliance, Inc., P.O. Box 44848, Madison, WI 53744; check the Product Support section of our website, wolfappliance.com, email us at customerservice@subzero.com or call 800-222-7820.

*Stainless steel (doors, panels, handles, product frames and interior surfaces) are covered by a limited 60-day parts and labor warranty for cosmetic defects.

*Replacement filters for ventilation hood recirculating kits are not covered by the product warranty.



Wolf Appliance Non-Residential Limited Warranty

FOR NON-RESIDENTIAL USE

SPECIAL APPLICATION

This warranty is designed specifically to cover products installed in demonstration kitchens, test kitchens, culinary and school kitchens and other similar installations that will help promote the Wolf Appliance brand and its products. Restaurant installations and other similar commercial applications are excluded and do not have applicable warranty.

FULL TWO YEAR WARRANTY*

For two years from the date of original installation, this Wolf Appliance product warranty covers all parts and labor to repair or replace, under normal residential use, any part of the product that proves to be defective in materials or workmanship. All service provided by Wolf Appliance under the above warranty must be performed by Wolf Factory Certified Service, unless otherwise specified by Wolf Appliance, Inc. Service will be provided during normal business hours.

TERMS APPLICABLE TO EACH WARRANTY

The warranty applies only to products installed in any one of the fifty states of the United States, the District of Columbia or the ten provinces of Canada. This warranty does not cover any parts or labor to correct any defect caused by negligence, accident or improper use, maintenance, installation, service or repair.

THE REMEDIES DESCRIBED ABOVE FOR EACH WARRANTY ARE THE ONLY ONES THAT WOLF APPLIANCE, INC. WILL PROVIDE, EITHER UNDER THIS WARRANTY OR UNDER ANY WARRANTY ARISING BY OPERATION OF LAW. WOLF APPLIANCE, INC. WILL NOT BE RESPONSIBLE FOR ANY CONSEQUENTIAL OR INCIDENTAL DAMAGES ARISING FROM THE BREACH OF THIS WARRANTY OR ANY OTHER WARRANTY, WHETHER EXPRESS, IMPLIED OR STATUTORY.

Some states do not allow the exclusion or limitation of incidental or consequential damages, so the above limitation or exclusion may not apply to you. This warranty gives you specific legal rights and you may also have other legal rights that vary from state to state.

To receive parts and/or service and the name of Wolf Factory Certified Service nearest you, contact Wolf Appliance, Inc., P.O. Box 44848, Madison, WI 53744; check the Product Support section of our website, wolfappliance.com, email us at customerservice@subzero.com or call 800-222-7820.

*Stainless steel (doors, panels, handles, product frames and interior surfaces) are covered by a limited 60-day parts and labor warranty for cosmetic defects.

*Replacement filters for ventilation hood recirculating kits are not covered by the product warranty.



20

20

